

# ***tillex***<sup>®</sup>

Professionals choose Tillex



High-quality products made in Denmark since 1954

Distributed by  
**GREEN  
BROOK**

## Welcome to our catalogue

Tillex is an established brand that has existed in Denmark for more than 60 years. With the help of our partner, GreenBrook Electrical, we are delighted to bring this superior quality range of plugs and fixings to the UK market.

All of our manufacturing still takes place in the company's own factories in Ringsted, Denmark. This enables us to guarantee uniform quality year in and year out. Our logistics are handled from GreenBrook's large warehouse facility in Harlow, Essex - which enables us to guarantee you next day delivery (on orders placed before 3pm either on-line or via the sales desk).

Tillex is an ultra-modern manufacturing company specialising in the production of fastenings for the wholesale market. We choose to use high-quality plastic materials, such as polypropylene, polystyrene, polyethylene, nylon, nails and all screws are made from top quality steel with a corrosion resistance class of C4.

BS8539:2012 is the Code of Practice for the selection and installation of post-installed anchors in concrete and masonry. Tillex can help you to conform to this standard by providing technical support to ensure the correct fixing selection. Whether its plugs, screws or plasterboard fixings, investing in Tillex means you can trust that they will deliver consistent and reliable results.

We have taken the time to consider all aspects of this range for the benefit of our customers, even down to the handy re-sealable boxes that hold our plugs and clips, to save the frustration of the items spilling out.

Please feel free to contact our team of experts with regard to specification or prices and we will be happy to help you.



## Contents Page

| <b>Description</b>                               | <b>Page Number</b> |
|--|--------------------|
| Cable Clips for Round & Flat Cable               | 4-5                |
| Cable Clips with Screw                           | 6-7                |
| Grooved Clips for Round Cable & Flexible Conduit | 8                  |
| Plugs for Cable Clips                            | 9                  |
| Stella Plugs                                     | 10-12              |
| Collar Plugs                                     | 13                 |
| Mandrel for Collar Plugs                         | 14                 |
| Flex Plugs                                       | 14                 |
| Attack Plugs                                     | 15                 |
| Universal Plugs with Collar                      | 15                 |



## Cable clips for round cable

Material: Impact resistant, UV-stabilized polypropylene, halogen free.  
Nail: Zinc plated hardened steel nail.



- For use in most materials
- In plasterboard, concrete, lightweight concrete and brick use it together with Tillex plugs for cable clips
- Available in several colours and sizes

| Part No. | Type      | Nail (mm) | Cable Type        | EAN           | Colour | Pieces/box |
|----------|-----------|-----------|-------------------|---------------|--------|------------|
| 101025   | C 3-5 W   | 1.2x16    | Telephone 4 Pair  | 5701925110816 | white  | 100        |
| 101026   | C 3-5 B   | 1.2x16    | Telephone 4 Pair  | 5701925101026 | black  | 100        |
| 101043   | C 5-7 W   | 1.2x20    | 2 Core Flex       | 5701925110915 | white  | 100        |
| 101045   | C 5-7 B   | 1.2x20    | 2 Core Flex       | 5701925111189 | black  | 100        |
| 101058   | C 5-7 Br  | 1.2x20    | 2 Core Flex       | 5701925119055 | brown  | 100        |
| 101081   | C 7-10 R  | 1.8x25    | 3 Core Flex/Co-ax | 5701925101081 | red    | 100        |
| 101100   | C 7-10 W  | 1.8x25    | 3 Core Flex/Co-ax | 5701925116412 | white  | 100        |
| 101140   | C 7-10 B  | 1.8x25    | 3 Core Flex/Co-ax | 5701925111585 | black  | 100        |
| 101330   | C 10-14 W | 2.0x30    |                   | 5701925116610 | white  | 100        |
| 101380   | C 10-14 B | 2.0x30    |                   | 5701925113282 | black  | 100        |
| 101570   | C 14-20 W | 2.0x35    |                   | 5701925117419 | white  | 100        |
| 101610   | C 14-20 B | 2.0x35    |                   | 5701925114487 | black  | 100        |
| 101680   | C 18-22 W | 2.0x45    |                   | 5701925117112 | white  | 100        |
| 101715   | C 18-22 B | 2.0x45    |                   | 5701925115088 | black  | 100        |
| 101775   | C 22-26 W | 2.0x45    |                   | 5701925118010 | white  | 50         |
| 101815   | C 22-26 B | 2.0x45    |                   | 5701925115682 | black  | 50         |

## Plug clips double, for round cable

Material: Impact resistant, UV-stabilized polypropylene, halogen free.  
Nail: Zinc plated hardened steel nail.

- For use in masonry and concrete
- Drill hole with 5.5-6 mm drill, mount plugs clip and hit the nail in
- Available in several colours and sizes

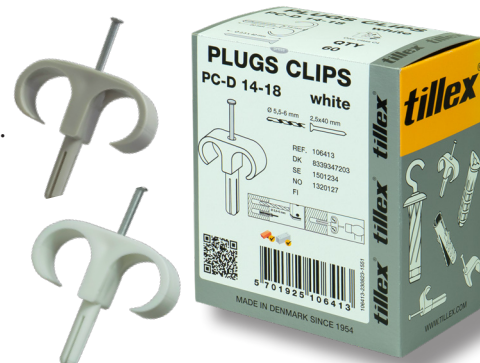

| Part No. | Type         | Nail (mm) | EAN           | Colour | Drill Ø (mm) | Pieces/Box |
|----------|--------------|-----------|---------------|--------|--------------|------------|
| 106413   | PC-D 14-18 W | 2.5x40    | 5701925106413 | white  | 5.5-6        | 60         |
| 106420   | PC-D 14-18 G | 2.5x40    | 5701925106420 | grey   | 5.5-6        | 60         |
| 108400   | PC-D 18-22 W | 2.5x45    | 5701925108400 | white  | 5.5-6        | 40         |
| 108431   | PC-D 18-22 G | 2.5x45    | 5701925108431 | grey   | 5.5-6        | 40         |

## Cable clips for flat cable

Material: Impact resistant, UV-stabilized polypropylene, halogen free.  
Nail: Zinc plated hardened steel nail.



- For use in most materials
- In plasterboard, concrete, lightweight concrete and brick use it together with Tillex plugs for cable clips
- Available in several colours and sizes

| Part No. | Type     | Nail (mm) | Cable Type    | EAN           | Colour | Pieces/Box |
|----------|----------|-----------|---------------|---------------|--------|------------|
| 110015   | C 2x4 C  | 1.2x16    | Bell Wire     | 5701925102705 | clear  | 100        |
| 110030   | C 3x5 C  | 1.2x20    | 2812X         | 5701925102408 | clear  | 100        |
| 110115   | C 4x6 C  | 1.2x20    | 3192Y         | 5701925101807 | clear  | 100        |
| 110135   | C 5x8 W  | 2.0x25    | 1 & 1.5mm T&E | 5701925103276 | white  | 100        |
| 110145   | C 5x8 G  | 2.0x25    | 1 & 1.5mm T&E | 5701925106079 | grey   | 100        |
| 110180   | C 6x10 W | 2.0x25    | 2.5mm T&E     | 5701925103016 | white  | 100        |
| 110199   | C 6x10 G | 2.0x25    | 2.5mm T&E     | 5701925110199 | grey   | 100        |
| 110200   | C 7x14 W | 2.0x25    | 4 & 6mm T&E   | 5701925103917 | white  | 100        |
| 110205   | C 7x14 G | 2.0x25    | 4 & 6mm T&E   | 5701925110205 | grey   | 100        |
| 110311   | C 9x18 W | 2.0x30    | 10 x 16mm T&E | 5701925110133 | white  | 100        |
| 110304   | C 9x18 G | 2.0x30    | 10 x 16mm T&E | 5701925110304 | grey   | 100        |

## Plug clips for round cable

Material: Impact resistant, UV-stabilized polypropylene, halogen free.  
Nail: Zinc plated hardened steel nail.



- For use in masonry and concrete
- Drill hole with 5.5-6 mm drill, mount plugs clip and hit the nail in
- Available in several colours and sizes

| Part No. | Type       | Nail (mm) | EAN           | Colour | Pieces/Box | Drill Ø (mm) |
|----------|------------|-----------|---------------|--------|------------|--------------|
| 102224   | PC 8-12 G  | 2.0x35    | 5701925102224 | grey   | 100        | 5.5-6        |
| 102217   | PC 8-12 W  | 2.0x35    | 5701925102217 | white  | 100        | 5.5-6        |
| 104228   | PC 10-14 G | 2.0x35    | 5701925104228 | grey   | 100        | 5.5-6        |
| 104211   | PC 10-14 W | 2.0x35    | 5701925104211 | white  | 100        | 5.5-6        |
| 106222   | PC 14-18 G | 2.5x40    | 5701925106222 | grey   | 100        | 5.5-6        |
| 106215   | PC 14-18 W | 2.5x40    | 5701925106215 | white  | 100        | 5.5-6        |
| 108233   | PC 18-22 G | 2.5x40    | 5701925108233 | grey   | 50         | 5.5-6        |
| 108202   | PC 18-22 W | 2.5x40    | 5701925108202 | white  | 50         | 5.5-6        |

## Cable clips with screw

A brand new timesaving product - ideal for when installing cable into joists or double layer plasterboard.





Material: Impact resistant, UV-stabilized polypropylene, halogen free.  
Screw: Strong concrete screw, Corrosion Class C4  
Can be installed both indoors and outdoors.

- For concrete and tile:screw directly into 4mm hole - no plug required
- For 13mm single-layer plasterboard: mount using yellow plug (KP yellow)
- For double-layer plasterboard - no plug required.
- For 13mm single-layer plasterboard on metal profile - no plug required
- For wood, fibreboard and plywood:screw directly into material
- For aerated concrete: mount using yellow plug (KP Yellow). For densities above 600, screw directly into concrete
- Installation torque:max 6,3 Nm in concrete C20/25



| Corrosivity category | Environmental corrosion | Examples of typical outdoor environments  | Examples of typical indoor environments  |
|----------------------|-------------------------|---|--|
| C1                   | Very low                | –   | Heated areas with dry air and minor amounts of impurities (e.g. offices, shops, schools, hotels)   |
| C2                   | Low                     | Environments with low levels of atmospheric pollution. Rural areas.   | Unheated areas with varying temperature and humidity levels. Low frequency of condensation and low level of atmospheric pollution, e.g. sports halls and warehouses. |
| C3                   | Moderate                | Environments with low salinity or moderate atmospheric pollution. Urban areas and light industrial areas. Areas with certain coastal influence. | Areas with moderate air humidity and some atmospheric pollution from production processes (e.g. breweries, dairies, laundries, etc.)                                 |
| C4                   | High                    | Environments with moderate salinity or significant atmospheric pollution. Industrial and coastal areas.   | Areas with high air humidity and high atmospheric pollution from production processes (e.g. chemical plants, swimming pools, shipyards, etc.)                        |
| C5-I                 | Very high (Industrial)  | Industrial areas with high air humidity and aggressive atmosphere.  | Areas with almost constant condensation and high levels of atmospheric pollution.  |
| C5-M                 | Very high (Maritime)    | Coastal and offshore areas with high salinity.  | Areas with almost constant condensation and high levels of atmospheric pollution.  |

## Cable clips with T20 screw for round cable

Material: Impact resistant, UV-stabilized polypropylene, halogen free.  
Screw: Strong concrete screw, Corrosion Class C4, TORX 20  
Can be installed both indoors and outdoors.

| Part No. | Type          | Screw T20 (mm)  | EAN           | Colour | Drill Ø (mm)  | Pieces/Box |
|----------|---------------|--|---------------|--------|--|------------|
| 180000   | SC C4 7-10 W  | 5x33   | 5701925180000 | white  | 4  | 100        |
| 180024   | SC C4 7-10 B  | 5x33   | 5701925180024 | black  | 4  | 100        |
| 180086   | SC C4 10-14 W | 5x40   | 5701925180086 | white  | 4  | 100        |
| 180109   | SC C4 10-14 B | 5x40   | 5701925180109 | black  | 4  | 100        |
| 180116   | SC C4 14-18 W | 5x40   | 5701925180116 | white  | 4  | 100        |
| 180130   | SC C4 14-18 B | 5x40   | 5701925180130 | black  | 4  | 100        |
| 180147   | SC C4 18-22 W | 5x45   | 5701925180147 | white  | 4  | 50         |
| 180161   | SC C4 18-22 B | 5x45   | 5701925180161 | black  | 4  | 50         |
| 180178   | SC C4 22-26 W | 5x45   | 5701925180178 | white  | 4  | 50         |
| 180192   | SC C4 22-26 B | 5x45   | 5701925180192 | black  | 4  | 50         |

## Cable clips with PH2 screw for round cable

| Part No. | Type          | Screw PH2 (mm)  | EAN            | Colour | Drill Ø (mm)  | Pieces/Box |
|----------|---------------|--|----------------|--------|--|------------|
| 170065   | SC C4 7-10 W  | 5x33   | 5701925171015  | white  | 4  | 100        |
| 170075   | SC C4 7-10 B  | 5x33   | 5701925 171282 | black  | 4  | 100        |
| 170005   | SC C4 10-14 W | 5x40   | 5701925170117  | white  | 4  | 100        |
| 170015   | SC C4 10-14 B | 5x40   | 5701925170780  | black  | 4  | 100        |
| 170025   | SC C4 14-18 W | 5x40   | 5701925170315  | white  | 4  | 100        |
| 170035   | SC C4 14-18 B | 5x40   | 5701925170889  | black  | 4  | 100        |
| 170045   | SC C4 18-22 W | 5x45   | 5701925170513  | white  | 4  | 50         |
| 170055   | SC C4 18-22 B | 5x45   | 5701925170988  | black  | 4  | 50         |
| 170100   | SC C4 22-26 W | 5x45   | 5701925170100  | white  | 4  | 50         |
| 170110   | SC C4 22-26 B | 5x45   | 5701925170025  | black  | 4  | 50         |

## Drill clips with screw for round cable

Material: Impact resistant, UV-stabilized polypropylene, halogen free.  
Screw: Strong self-drilling screw, Corrosion Class C4, PH2/TORX 20  
Can be installed both indoors and outdoors.

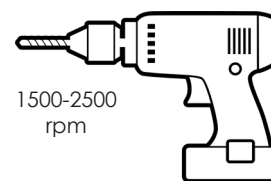

- For installation in sheet metal
- Strong self tapping screw 4.8 x 40mm with drill shaped tip allows it to mount directly in sheet metal - max. 2.0mm, without having to drill a pilot hole
- Recommended speed: 1500-2500 rpm
- PH2/T20 screw types

| Part No. | Type          | Screw PH2 (mm)  | EAN           | Colour | Pieces/Box |
|----------|---------------|--|---------------|--------|------------|
| 150096   | DC C4 14-18 W | 4.8 x 40   | 5701925150096 | white  | 100        |
| 150102   | DC C4 14-18 G | 4.8 x 40   | 5701925150102 | grey   | 100        |
| 150126   | DC C4 18-22 W | 4.8 x 40   | 5701925150126 | white  | 50         |
| 150133   | DC C4 18-22 G | 4.8 x 40   | 5701925150133 | grey   | 50         |

  

| Part No. | Type          | Screw T20 (mm)  | EAN           | Colour | Pieces/Box |
|----------|---------------|--|---------------|--------|------------|
| 160095   | DC C4 14-18 W | 4.8 x 40   | 5701925160095 | white  | 100        |
| 160101   | DC C4 14-18 G | 4.8 x 40   | 5701925160101 | grey   | 100        |
| 160125   | DC C4 18-22 W | 4.8 x 40   | 5701925160125 | white  | 50         |
| 160132   | DC C4 18-22 G | 4.8 x 40   | 5701925160132 | grey   | 50         |



## Grooved clips for round cable & flexible conduits

Material: Impact resistant, UV-stabilized polypropylene, halogen free.

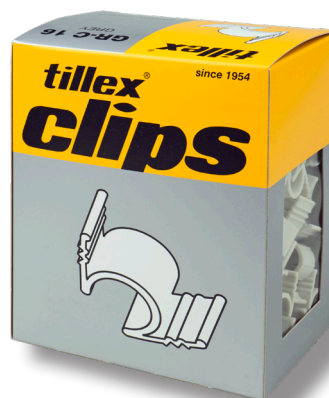
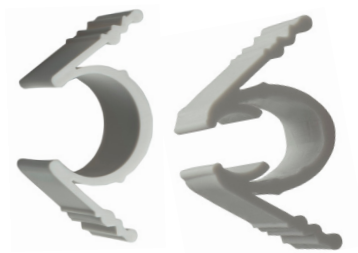

- Fast and time-saving installation of flexible conduits and cables into walls, without use of any tools
- Easy to remove, leaves NO damage in the wall
- No rust through the wall - plastic does not rust!
- Suitable for 16 mm / 20 mm pipes.

Installation of GR-C16 / GR-C20:

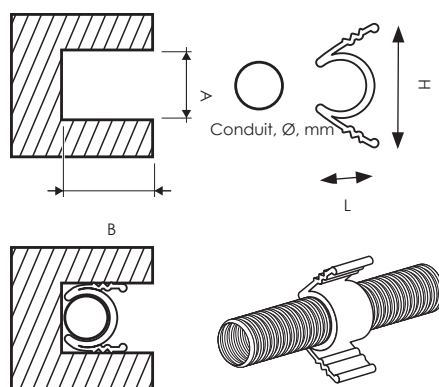

| Part No. | Type    | EAN           | Colour | Dim. L, mm. | Dim. H, mm. | Dim. A, mm. | Dim. B, mm. | Conduit, mm. | Pieces/Box |
|----------|---------|---------------|--------|-------------|-------------|-------------|-------------|--------------|------------|
| 120044   | GR-C 16 | 5701925120044 | grey   | 20.4        | 36          | 23          | 30          | 16           | 100        |
| 120068   | GR-C 20 | 5701925120068 | grey   | 21.8        | 41.2        | 28          | 35          | 20           | 80         |

## Plugs for cable clips

Material: Impact resistant, UV-stabilized polypropylene, halogen free.

- The plug expands when driving a nail in
- Perfectly suitable for installing of Tillex cable clips

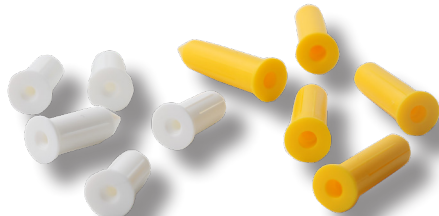

| Part No. | Type      | Dimension, (mm) | EAN           | Colour | Drill Ø (mm) | Pieces/Box |
|----------|-----------|-----------------|---------------|--------|--------------|------------|
| 300015   | CP white  | 5.5x20          | 5701925201514 | white  | 5.5          | 100        |
| 300025   | CP yellow | 5.5x25          | 5701925201224 | yellow | 5.5          | 100        |

Our high quality packaging has a handy re-sealable lid to save the items from spilling out into toolboxes



## Stella Plugs

Material: High quality recycled Nylon (Polyamid 6).  
Halogen free and withstand temperatures from  $-40^{\circ}\text{C}$  to  $+80^{\circ}\text{C}$ .  
The screws are 4.8 steel, zinc-plated min. 5  $\mu\text{m}$ .



These screw plugs are protected by EU Design N 778.345

- High load capacity.
- Easy fixing – needs NO special tools.
- Equally effective for insulated cavities.
- Will not damage the plasterboard.
- Encapsulated metal nut for high strength
- Plug is removable
- Only to be fixed by screwdriver with torque control or by hand

Stella plug makes it easy to fix heavy objects like shelves, radiators, cupboards, light fittings, lamps and duct moldings in all types of boards used in cavity walls.

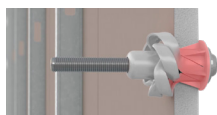

1 layer plasterboard  
(13mm)

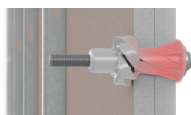

2 layers plasterboard  
(26 mm)

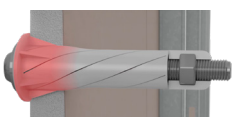
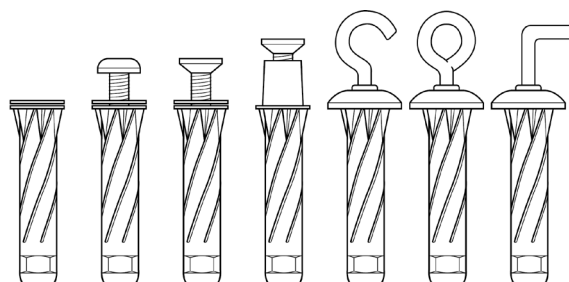

**Note:** Inside the tip of the Tillex Stella plug is a metal nut. When the screw engages the nut, the plug is contracted to form a star-shaped knot behind the board, inside the cavity. The installation is now complete.

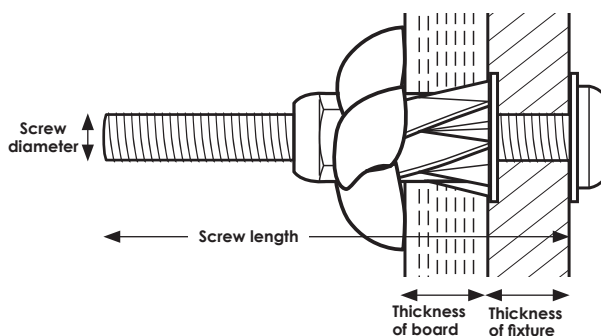
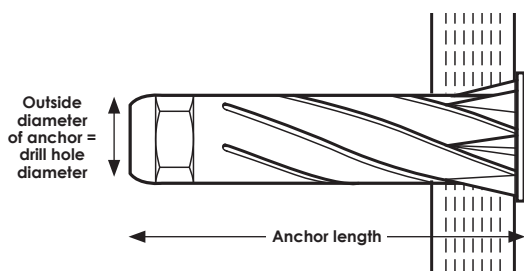

## Stella Plugs 10x59, for single & double layer plasterboard

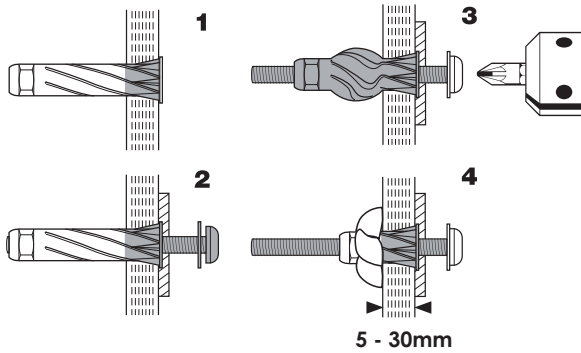





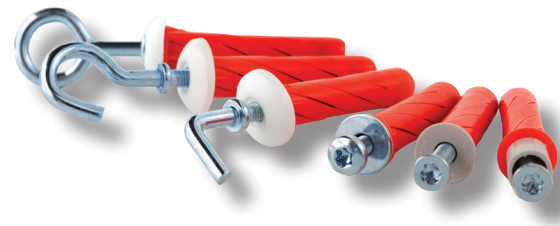
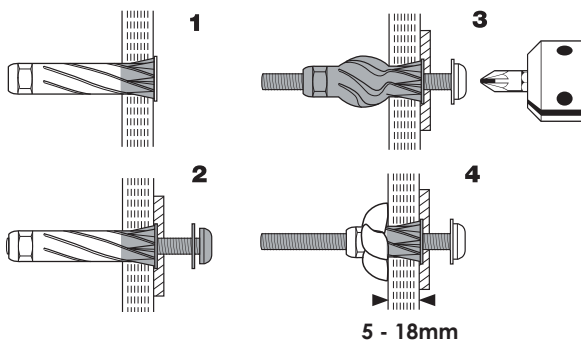









| Part No. | Type                             | EAN           | Screw (mm) | Pieces/Box |
|----------|----------------------------------|---------------|------------|------------|
| 330045   | ST Black Pan Torx 25             | 5701925253186 | 5x65       | 25         |
| 330047   | ST Black Pan Torx 25             | 5701925251489 | 5x90       | 25         |
| 330051   | ST Black Pan PZ2                 | 5701925251687 | 5x65       | 25         |
| 330053   | ST Black Pan PZ2                 | 5701925253285 | 5x90       | 25         |
| 330056   | ST Black UHJ Torx 25             | 5701925251885 | 5x75       | 25         |
| 330058   | ST Black UHJ Torx 25             | 5701925253384 | 5x90       | 25         |
| 330061   | ST Black Collum Torx 25          | 5701925252080 | 5x75       | 25         |
| 330066   | ST Black Eye                     | 5701925252486 | 5x55       | 25         |
| 330071   | ST Black Hook                    | 5701925252684 | 5x55       | 25         |
| 330076   | ST Black Angle                   | 5701925252882 | 5x55       | 25         |
| 330054   | Stella Black 10x59 without screw | 5701925330054 |            | 50         |

## Stella Plugs 10x49, for single layer plasterboard

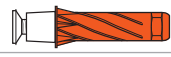
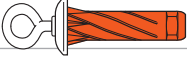

| Part No. | Type                           | EAN           | Screw (mm) | Pieces/Box |
|----------|--------------------------------|---------------|------------|------------|
| 330005   | ST Red Pan Torx 25             | 5701925252844 | 5x55       | 25         |
| 330007   | ST Red Pan Torx 25             | 5701925251342 | 5x80       | 25         |
| 330011   | ST Red Pan PZ2                 | 5701925251540 | 5x55       | 25         |
| 330013   | ST Red Pan PZ2                 | 5701925252943 | 5x80       | 25         |
| 330016   | ST Red UHJ Torx 25             | 5701925251748 | 5x65       | 25         |
| 330018   | ST Red UHJ Torx 25             | 5701925253049 | 5x80       | 25         |
| 330021   | ST Red Collum Torx 25          | 5701925251946 | 5x65       | 25         |
| 330026   | ST Red Eye                     | 5701925252349 | 5x55       | 25         |
| 330031   | St Red Hook                    | 5701925252547 | 5x55       | 25         |
| 330036   | St Red Angle                   | 5701925252745 | 5x55       | 25         |
| 330009   | Stella Red 10x49 without screw | 5701925330009 |            | 50         |

| Stella Plugs Black  |  |         |          | Dimensions             |                   |             |             |                          | Fitting         |                          |              | Load capacity*              |
|---------------------|--|---------|----------|------------------------|-------------------|-------------|-------------|--------------------------|-----------------|--------------------------|--------------|-----------------------------|
| Type                | Assortment   | Bit     | Part No. | Outside Ø of anchor mm | Anchor length, mm | Screw Ø, mm | Screw L, mm | Thick-ness of fixture mm | Drill hole Ø mm | Thick-ness of fixture mm | Board layers | Recommended tension load kg |
| Black Pan           |   | -       | 330054   | 10                     | 59                | M5          | -           | 0                        | 10              | 5-30                     | 2            | 20                          |
| Black Pan           |   | Torx 25 | 330045   | 10                     | 59                | M5          | 65          | 12                       | 10              | 5-30                     | 2            | 45                          |
|                     |  |         | 330047   | 10                     | 59                | M5          | 90          | 38                       | 10              | 5-30                     | 2            | 45                          |
| Black Pan           |   | PZ2     | 330051   | 10                     | 59                | M5          | 65          | 12                       | 10              | 5-30                     | 2            | 45                          |
|                     |  |         | 330053   | 10                     | 59                | M5          | 90          | 38                       | 10              | 5-30                     | 2            | 45                          |
| Black UHJ           |   | Torx 25 | 330056   | 10                     | 59                | M5          | 75          | 23                       | 10              | 5-30                     | 2            | 45                          |
|                     |  |         | 330058   | 10                     | 59                | M5          | 90          | 38                       | 10              | 5-30                     | 2            | 45                          |
| Black Collum        |   | Torx 25 | 330061   | 10                     | 59                | M5          | 75          | 12                       | 10              | 5-30                     | 2            | 45                          |
| Black Eye (Ø13mm)   |   |         | 330066   | 10                     | 59                | M5          | 55          | 0                        | 10              | 5-30                     | 2            | 20                          |
| Black Hook (Ø 13mm) |   |         | 330071   | 10                     | 59                | M5          | 55          | 0                        | 10              | 5-30                     | 2            | 20                          |
| Black Angle         |  |         | 330076   | 10                     | 59                | M5          | 55          | 0                        | 10              | 5-30                     | 2            | 20                          |

| Stella Plugs Red  |   |         |          | Dimensions             |                   |             |             |                          | Fitting         |                          |              | Load capacity*              |
|-------------------|---|---------|----------|------------------------|-------------------|-------------|-------------|--------------------------|-----------------|--------------------------|--------------|-----------------------------|
| Type              | Assortment  | Bit     | Part No. | Outside Ø of anchor mm | Anchor length, mm | Screw Ø, mm | Screw L, mm | Thick-ness of fixture mm | Drill hole Ø mm | Thick-ness of fixture mm | Board layers | Recommended tension load kg |
| Red Pan           |  | -       | 330009   | 10                     | 49                | M5          | -           | 0                        | 10              | 5-18                     | 1            | 20                          |
| Red Pan           |  | Torx 25 | 330005   | 10                     | 49                | M5          | 55          | 15                       | 10              | 5-18                     | 1            | 25                          |
|                   |   |         | 330007   | 10                     | 49                | M5          | 80          | 40                       | 10              | 5-18                     | 1            | 25                          |
| Red Pan           |  | PZ2     | 330011   | 10                     | 49                | M5          | 55          | 15                       | 10              | 5-18                     | 1            | 25                          |
|                   |   |         | 330013   | 10                     | 49                | M5          | 80          | 40                       | 10              | 5-18                     | 1            | 25                          |
| Red UHJ           |  | Torx 25 | 330016   | 10                     | 49                | M5          | 65          | 25                       | 10              | 5-18                     | 1            | 25                          |
|                   |   |         | 330018   | 10                     | 49                | M5          | 80          | 40                       | 10              | 5-18                     | 1            | 25                          |
| Red Collum        |  | Torx 25 | 330021   | 10                     | 49                | M5          | 65          | 12                       | 10              | 5-18                     | 1            | 25                          |
| Red Eye (Ø13mm)   |  |         | 330026   | 10                     | 49                | M5          | 55          | 0                        | 10              | 5-18                     | 1            | 20                          |
| Red Hook (Ø 13mm) |  |         | 330031   | 10                     | 49                | M5          | 55          | 0                        | 10              | 5-18                     | 1            | 20                          |
| Red Angle         |  |         | 330036   | 10                     | 49                | M5          | 55          | 0                        | 10              | 5-18                     | 1            | 20                          |

**Note:** The cavity must be at least as wide as the larger of either 1) Anchor length less thickness of board, or 2) Screw length less thickness of board and fixture.

\***Load capacity** is the recommended maximum load in plasterboards with 300 mm spacing between each Stella plug.

**Safety factor 3** is included. 1 kN ≈ 100 kg.

**Note:** If recommended dimensions and spacings cannot be respected, the load capacity is reduced.

## Collar plugs, double expanding

Material: High quality recycled Polyethylene (HDPE). Halogen free.  
Colour Code Licensed System Coordinated with Thorsman

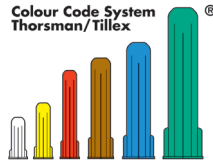
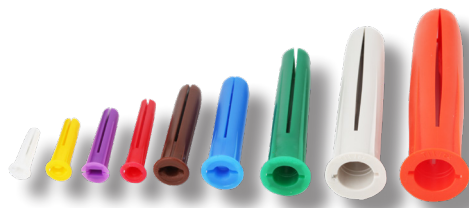

- Universal
- Plug expanding in both directions
- Suitable for wall, concrete, stone, light-weight concrete and cavity
- Colour Code Licensed System on the boxes makes it easy to choose the right size
- The collar and wings prevents the plug from rotating and disappearing into the hole.

| Part No. | Type      | Dimension (mm) | EAN           | Colour | Min.drill hole depth | Drill Ø (mm) | Screw Ø (mm) | Pieces/ Box |
|----------|-----------|----------------|---------------|--------|----------------------|--------------|--------------|-------------|
| 320001   | KP white  | 5.5x20         | 5701925245013 | white  | 25                   | 5.5          | 3-5          | 100         |
| 320015   | KP yellow | 5.5x25         | 5701925241329 | yellow | 30                   | 5.5          | 4-5          | 100         |
| 320035   | KP purple | 5.5x30         | 5701925241534 | purple | 35                   | 5.5          | 4-5          | 100         |
| 320055   | KP red    | 5.5x35         | 5701925242647 | red    | 40                   | 5.5          | 4-5          | 100         |
| 320075   | KP brown  | 8.0x40         | 5701925240957 | brown  | 45                   | 8            | 5-6          | 100         |
| 320095   | KP blue   | 10x45          | 5701925241169 | blue   | 55                   | 10           | 6-8          | 100         |
| 320115   | KP green  | 12x60          | 5701925240377 | green  | 70                   | 12           | 8-10         | 50          |
| 320135   | KP grey   | 14x70          | 5701925242289 | grey   | 80                   | 14           | 10-12        | 50          |
| 320145   | KP orange | 16x80          | 5701925243002 | orange | 90                   | 16           | 12           | 30          |
| 320550   | KP yellow | 5.5x25         | 5701925246225 | yellow | 30                   | 5,5          | 4-5          | 750         |
| 320560   | KP red    | 5.5x35         | 5701925246348 | red    | 40                   | 5,5          | 4-5          | 500         |

## Collar plugs - Tillex XXL

Material: High quality recycled Polyethylene (HDPE). Halogen free.  
Colour Code Licensed System Coordinated with Thorsman

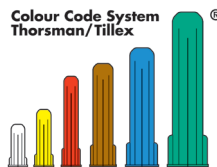

| Part No. | Type      | Dimension (mm) | EAN           | Colour | Min.drill hole depth | Drill Ø (mm) | Screw Ø (mm) | Pieces/ Box |
|----------|-----------|----------------|---------------|--------|----------------------|--------------|--------------|-------------|
| 322318   | KP yellow | 5.5x25         | 5701925322318 | yellow | 30                   | 5.5          | 4-5          | 7000        |
| 322127   | KP red    | 5.5x35         | 5701925322127 | red    | 40                   | 5.5          | 4-5          | 7000        |

## Collar plugs PLUS - double expanding

| Part No. | Type     | Dimension (mm) | EAN           | Colour | Drill Ø (mm) | Pieces/ Box |
|----------|----------|----------------|---------------|--------|--------------|-------------|
| 320054   | KP red + | 5.5x35         | 5701925320055 | red    | 5.5          | 100         |



## Mandrel for use with Collar plugs PLUS

Material: High quality recycled Nylon (Polyamid 6).  
Halogen free and withstand temperatures from -40 °C to +80°C.

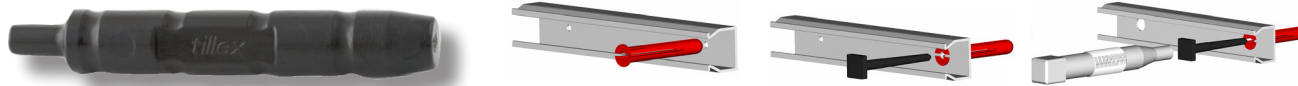

| Part No. | Type    | Dimension (mm) | EAN           | Colour | Pieces/Packaging |
|----------|---------|----------------|---------------|--------|------------------|
| 340015   | Mandrel | 97x13          | 5701925340015 | black  | 1                |

## Flex plugs - double expanding, FP

Material: High quality recycled Nylon (Polyamid 6).  
Halogen free and withstand temperatures from -40 °C to +80°C



- Suitable for masonry and concrete
- Adapted for wood, self-tapping and chipboard screws
- Special design prevents fixing rotating in the drill hole
- For push-through installation

| Part No. | Type  | Dimension (mm) | EAN           | Colour | Min.drill hole depth | Drill Ø (mm) | Screw Ø (mm) | Pieces/Box |
|----------|-------|----------------|---------------|--------|----------------------|--------------|--------------|------------|
| 370005   | FP 5  | 5x25           | 5701925262379 | grey   | 35                   | 5            | 3.5-4.5      | 100        |
| 370035   | FP 6  | 6x30           | 5701925262577 | grey   | 40                   | 6            | 4-5          | 100        |
| 370065   | FP 8  | 8x40           | 5701925262775 | grey   | 50                   | 8            | 5-6          | 100        |
| 370095   | FP 10 | 10x50          | 5701925262973 | grey   | 60                   | 10           | 6-8          | 50         |
| 370135   | FP 12 | 12x60          | 5701925263178 | grey   | 70                   | 12           | 8-10         | 25         |
| 370165   | FP 14 | 14x75          | 5701925263376 | grey   | 85                   | 14           | 10-12        | 20         |

### Load capacity, kN (1kN ≈ 100 kg)

Loads: Safety factor 3 is included.

Loads are tensile loads with highest screw diameter (recommended)

Screws are chipboard screws, higher loads (up to 30%), can be obtained by using traditional wood screws.

| Material                   | FP 5 | FP 6 | FP 8 | FP 10 | FP 12 | FP 14 |
|----------------------------|------|------|------|-------|-------|-------|
| Concrete C 20/25           | 0.5  | 0.7  | 1.75 | 2     | 5.6   | 8.1   |
| Aerated concrete 525 kg/m3 | -    | 0.2  | 0.2  | 0.6   | 0.8   | 1.1   |

## Attack plugs, AP

Material: High quality recycled Nylon (Polyamid 6).  
Halogen free and withstand temperatures from -40 °C to +80°C



- Special fixing for lightweight concrete, aerated concrete and Leca blocks
- Quick and easy fixing - needs no special tools
- Triangular shape and collar prevents fixing rotating and disappearing into the hole.
- Suitable for wood, self-tapping and chipboard screws

| Part No. | Type  | Dimension (mm) | EAN           | Colour | Min.drill hole depth | Drill Ø (mm) | Screw Ø (mm) | Pieces/Box |
|----------|-------|----------------|---------------|--------|----------------------|--------------|--------------|------------|
| 390001   | AP 10 | 10x55          | 5701925282773 | grey   | 65                   | 10           | 5-6          | 50         |
| 390015   | AP 12 | 12x60          | 5701925282872 | grey   | 70                   | 12           | 8            | 40         |
| 390005   | AP 14 | 14x75          | 5701925282971 | grey   | 85                   | 14           | 10           | 20         |

### Load capacity, kN (1kN ≈ 100 kg)

Loads: Safety factor 3 is included.

Loads are tensile loads with highest screw diameter (recommended)

Screws are chipboard screws, higher loads (up to 30%), can be obtained by using traditional wood screws.

| Material                               | AP 10 | AP 12 | AP 14 |
|--|-------|-------|-------|
| Aerated concrete 525 kg/m <sup>3</sup> | 0.7   | 0.85  | 1.15  |

## Universal plugs with collar, UPK

Material: High quality recycled Polyethylene (HDPE). Halogen free.



- Suitable for nearly all buildings materials
- Special design prevents rotation and in the drill hole
- The collar prevents plug from the disappearing into the hole
- Suitable for wood, self-tapping and chipboard screws

| Part No. | Type    | Dimension (mm) | EAN           | Colour | Min.drill hole depth | Drill Ø (mm) | Screw Ø (mm) | Pieces/Box |
|----------|---------|----------------|---------------|--------|----------------------|--------------|--------------|------------|
| 290005   | UP K 5  | 5x30           | 5701925190177 | grey   | 40 mm                | 5            | 3-4          | 100        |
| 290015   | UP K 6  | 6x35           | 5701925190276 | grey   | 45 mm                | 6            | 4-5          | 100        |
| 290025   | UP K 8  | 8x50           | 5701925190175 | grey   | 60 mm                | 8            | 5-6          | 100        |
| 290035   | UP K 10 | 10x60          | 5701925190474 | grey   | 70 mm                | 10           | 6-8          | 50         |

# ***tillex***<sup>®</sup>

## Professionals choose Tillex

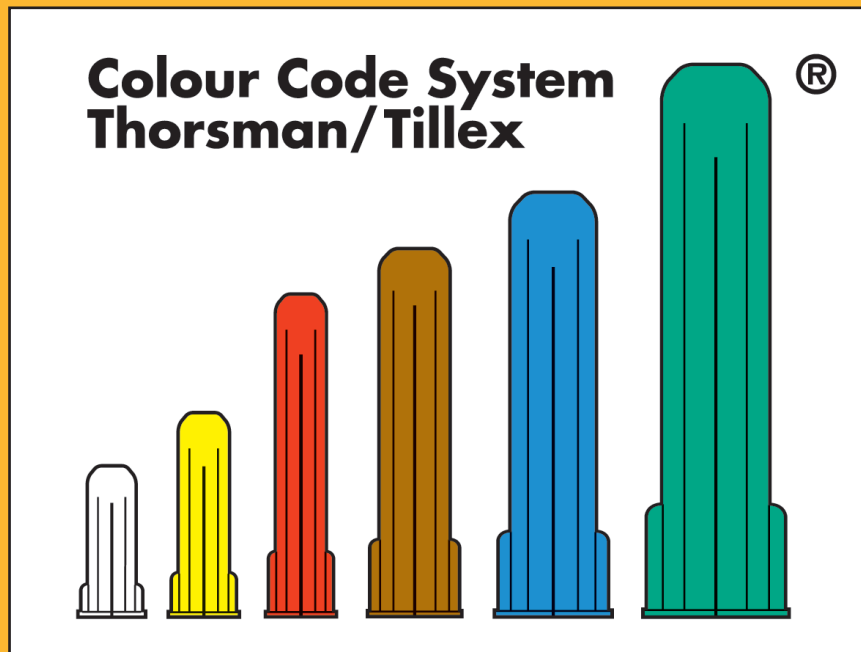

### **GREEN BROOK**

West Road, Harlow, Essex CM20 2BG  
T. 01279 772 770  
bdt@greenbrook.co.uk  
www.greenbrook.co.uk

Issue No. 707845